

Installation Guide Smart-UPS™ X 2000/2200/3000 VA Tower/Rack-Mount 4U

Important Safety Messages

Read the instructions carefully to become familiar with the equipment before trying to install, operate, service or maintain it. The following special messages may appear throughout this manual or on the equipment to warn of potential hazards or to call attention to information that clarifies or simplifies a procedure.



The addition of this symbol to a Caution product safety label indicates that a hazard exists that can result in injury and product damage if the instructions are not followed.

The following safety messages may appear throughout this manual to warn of potential hazards.

⚠ CAUTION

CAUTION indicates a potentially hazardous situation which, if not avoided, **can result in** equipment damage and minor or moderate injury.

CAUTION

CAUTION indicates a potentially hazardous situation which, if not avoided, **can result in** equipment damage.

Safety and General Information

Read the Safety Guide supplied with this unit before installing the UPS.

- Adhere to all local and national electrical codes.
- This UPS is intended for indoor use only.
- Do not operate this UPS in direct sunlight, in contact with fluids, or where there is excessive dust or humidity.
- Be sure the air vents on the UPS are not blocked. Allow adequate space for proper ventilation.
- The battery typically lasts for two to five years. Environmental factors impact battery life. Elevated ambient temperatures, poor quality utility power, and frequent short duration discharges will shorten battery life.
- Connect the UPS power cable directly to a wall outlet. Do not use surge protectors or extension cords.
- The batteries are heavy. Remove the batteries prior to installing the UPS in a rack.
- Always install external battery packs (XLBPs) at the bottom of the rack. The UPS must be installed above the XLBPs.
- The UPS display interface will recognize as many as 10 external battery packs connected to the UPS. However there is no limit to the number of XLBPs that can be used with the UPS.
- Refer to **Specifications** in the Operation manual for UPS and battery weight.

Inventory

Inspect the contents upon receipt. Notify the carrier and dealer if the unit is damaged.

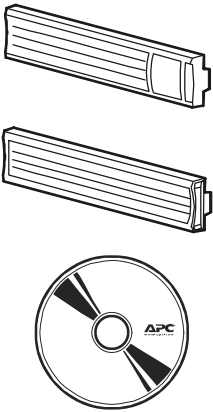
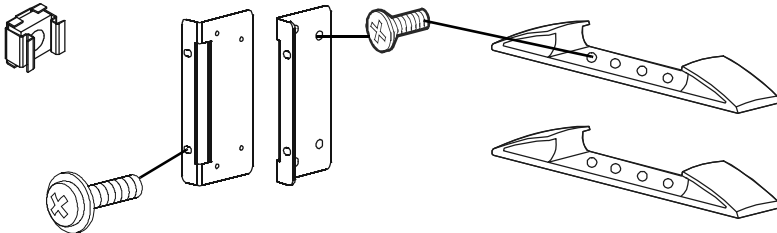
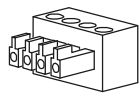
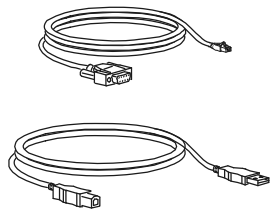
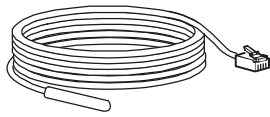
<p>Included with all models</p> 			<p>1 pair tower stabilizer brackets Use 8 flat head screws to secure tower stabilizer brackets to the UPS</p> <p>1 pair rack-mount brackets Use 8 flat head screws to secure rack-mount brackets to the UPS</p> <p>Use 4 ornamental screws to secure rack-mount brackets to the rails</p> <p>Install a cage nut in the rack to secure the top hole of each rack-mount bracket in a four post rack</p> 
		<p>Included with models that have factory installed Network Management Cards</p> 	

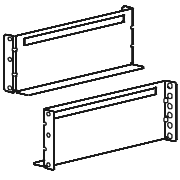
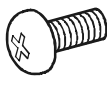
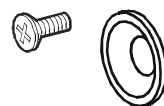
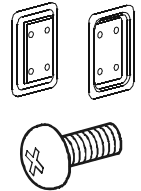
<p>Rail kit</p>			
<p>1 pair support brackets</p> 	<p>Two post racks 10 screws</p> 	<p>Four post racks 6 screws 6 washers</p> 	<p>1 pair rail cleats 8 pan head screws</p> 

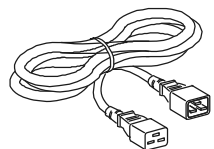
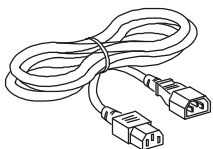
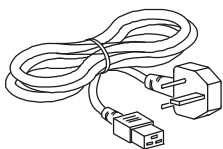
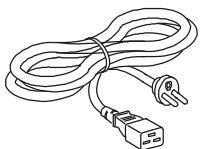
<p>Included with High Voltage (HV) models</p>			
			

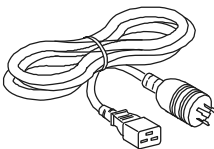
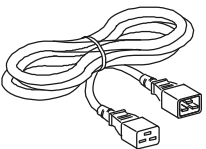
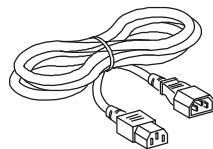
<p>Included with model SMX3000HVT</p>		
		

Product Overview

Front panel features

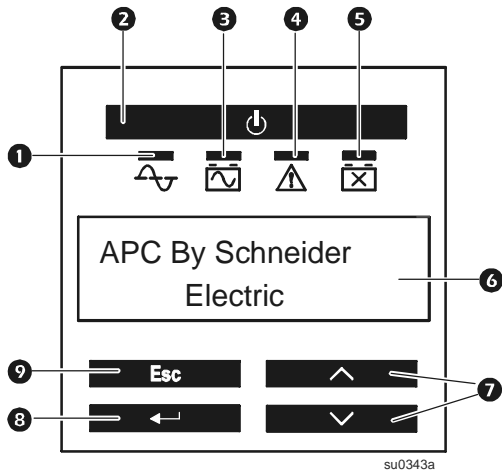

- ❶ Online LED
- ❷ Power ON/OFF button
- ❸ On Battery LED
- ❹ Site Wiring Fault LED
- ❺ Replace Battery LED
- ❻ LCD display screen
- ❼ UP/DOWN arrow keys
- ❽ ENTER key
- ❾ ESC key

Rear panel features

- ❶ SmartSlot
- ❷ Chassis ground screw
- ❸ UPS utility power input
- ❹ Circuit Breaker reset
- ❺ Controllable Outlet Group 1
- ❻ Controllable Outlet Group 2
- ❼ Controllable Outlet Group 3
- ❽ External battery pack connector
- ❾ EPO connector
- ❿ Serial port
- ⓫ USB port

2000 VA, 120 Vac Low Voltage

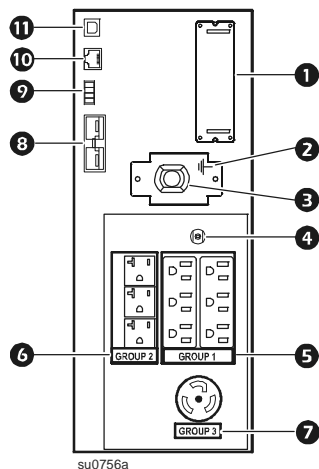

3000 VA, 120 Vac Low Voltage

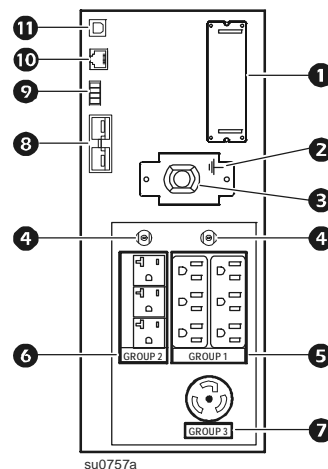

2200/3000 VA, 230 Vac High Voltage

3000 VA, 208 Vac High Voltage

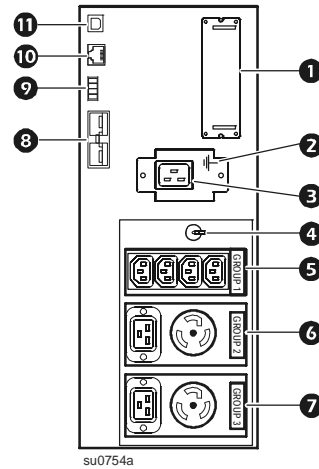
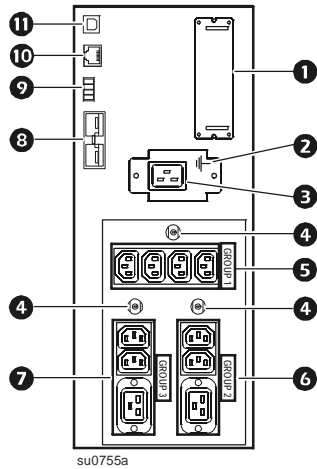

Remove Battery

⚠ CAUTION

DAMAGE TO EQUIPMENT OR PERSONNEL

- The equipment is heavy. Always practice safe lifting techniques adequate for the weight of the equipment.
- The UPS with battery installed weighs 41 kg (90.4 lb).
- The battery weighs 23.8 kg (52.4 lb). Remove the battery before installing the unit in a rack.
- Use the battery handle to lift and slide the battery out of the UPS.

Failure to follow these instructions can result in equipment damage and minor or moderate injury

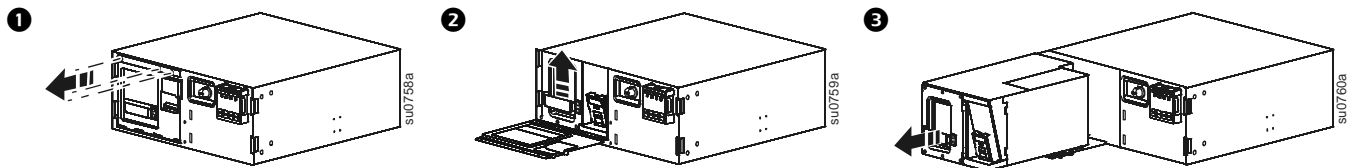

Tower Configuration

⚠ CAUTION

DAMAGE TO EQUIPMENT OR PERSONNEL

- The equipment is heavy. Always practice safe lifting techniques adequate for the weight of the equipment.
- The UPS with battery installed weighs 41 kg (90.4 lb).
- The battery weighs 23.8 kg (52.4 lb). Remove the battery before installing the unit in a rack.
- Use the battery handle to lift and slide the battery out of the UPS.

Failure to follow these instructions can result in equipment damage and minor or moderate injury

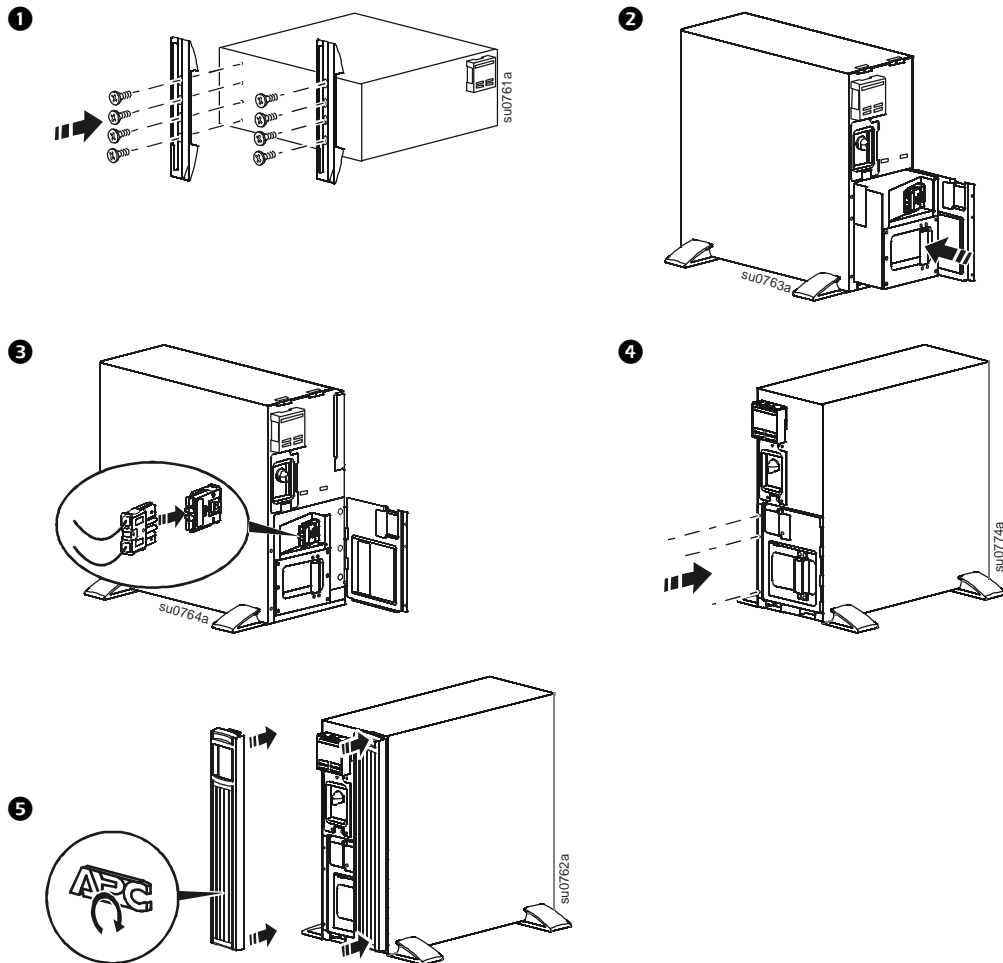

Rack-Mount Configuration

<p>⚠ CAUTION</p> <p>DAMAGE TO EQUIPMENT OR PERSONNEL</p> <ul style="list-style-type: none"> • The equipment is heavy. Always practice safe lifting techniques adequate for the weight of the equipment. • The UPS with the battery installed weighs 41 kg (90.4 lb). • The battery weighs 23.8 kg (52.4 lb). Remove the battery before installing the unit in a rack. • Use the battery handle to lift and slide the battery out of the UPS. <p>Failure to follow these instructions can result in equipment damage and minor or moderate injury</p>

Tower to rack-mount conversion

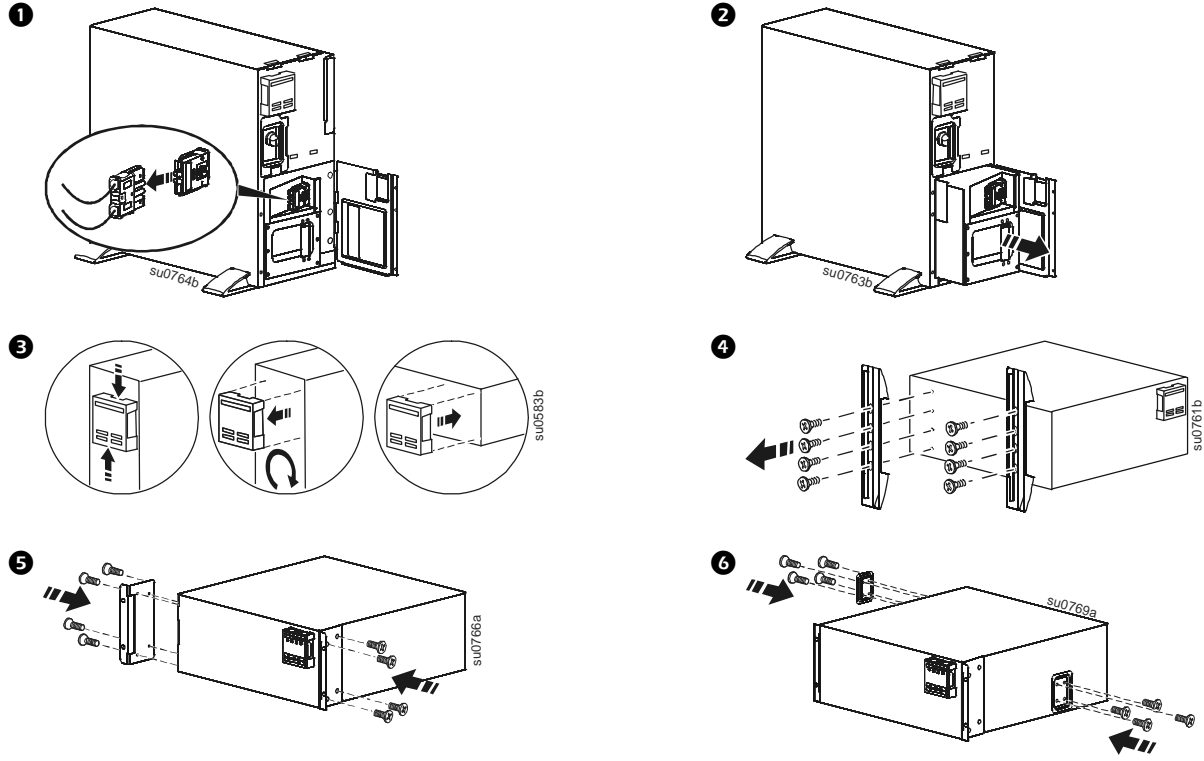

⚠ CAUTION

DAMAGE TO EQUIPMENT OR PERSONNEL

- When installing equipment in a rack, always install external battery packs at the bottom of the rack.
- The UPS should always be installed above the external battery packs in rack or stack configurations.

Failure to follow these instructions can result in equipment damage and minor or moderate injury

Two post rack installation

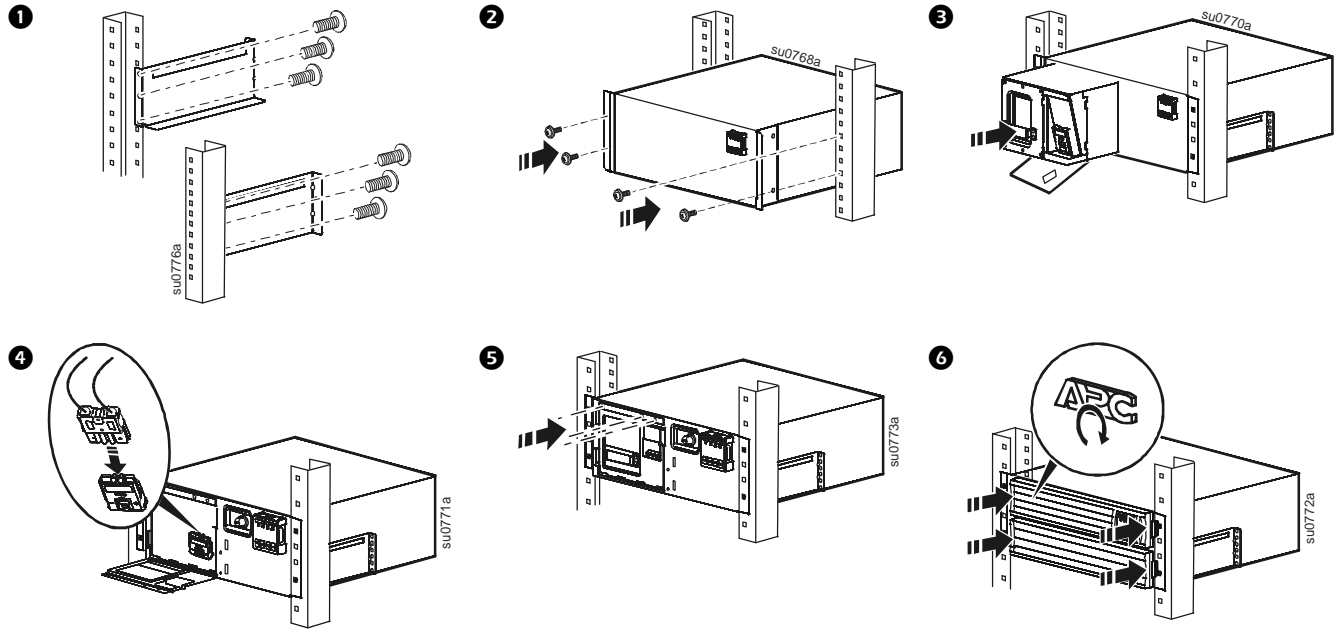

Four post rack installation

Use an APC by Schneider Electric four post rail kit. To order the rail kit go to the APC by Schneider Electric Web site apc.com.

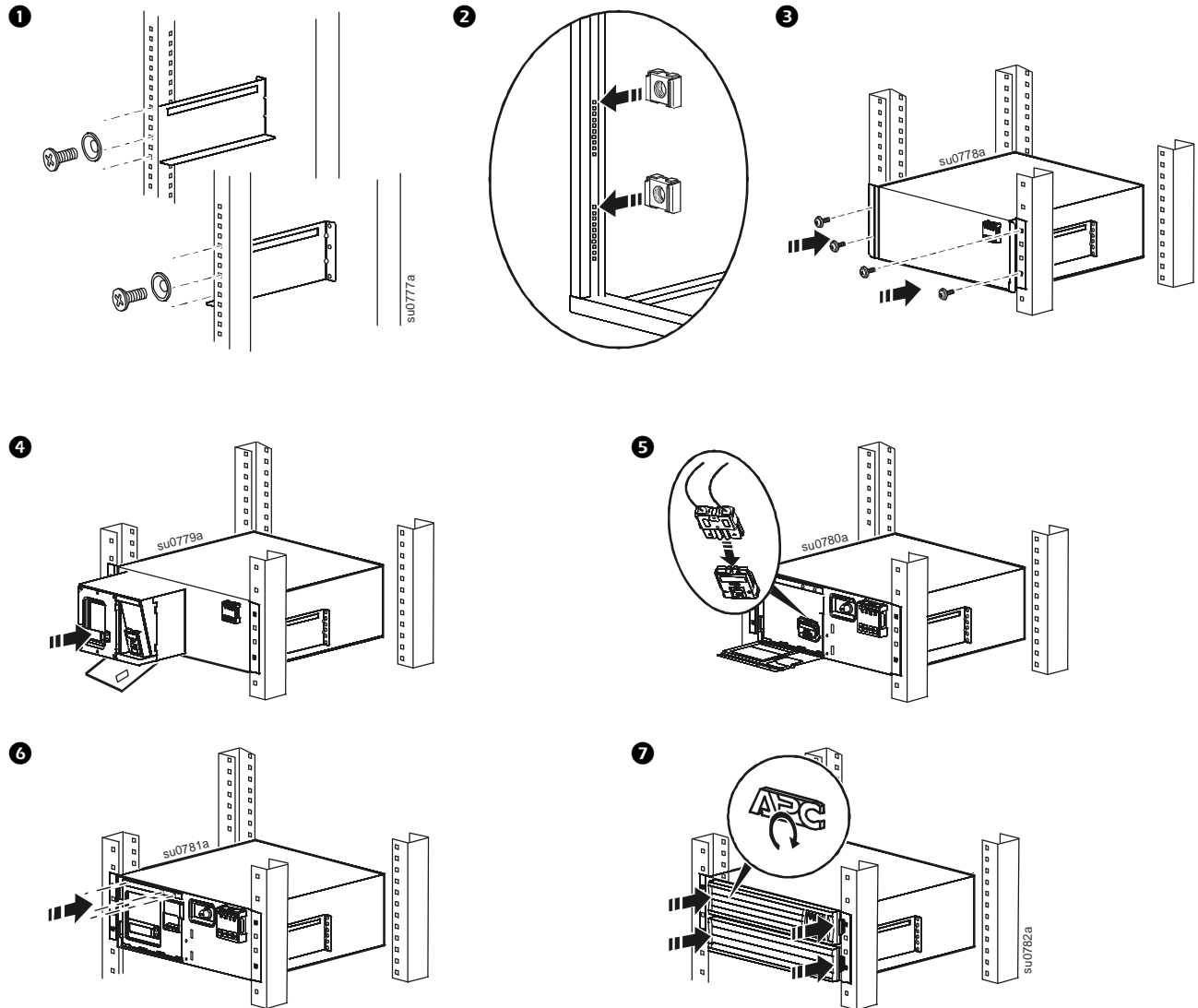

UPS Configuration

Connect Emergency Power Off feature

For instructions on how to connect the Emergency Power Off (EPO) switch, refer to the Operation and Maintenance manual on the Documentation CD (supplied).

Configure controllable outlet groups

The outlets on the UPS are configured into groups. To utilize the controlled outlet features, use the **Advanced** menus on the display interface and navigate to: **Main Menu > Control > Outlet1 Control**.

Electrical connections

CAUTION

RISK OF EQUIPMENT DAMAGE

- Adhere to all local and national electrical codes.
- Wiring should be performed by qualified electrician.
- Always connect the UPS to a grounded outlet.

Failure to follow these instructions can result in equipment damage

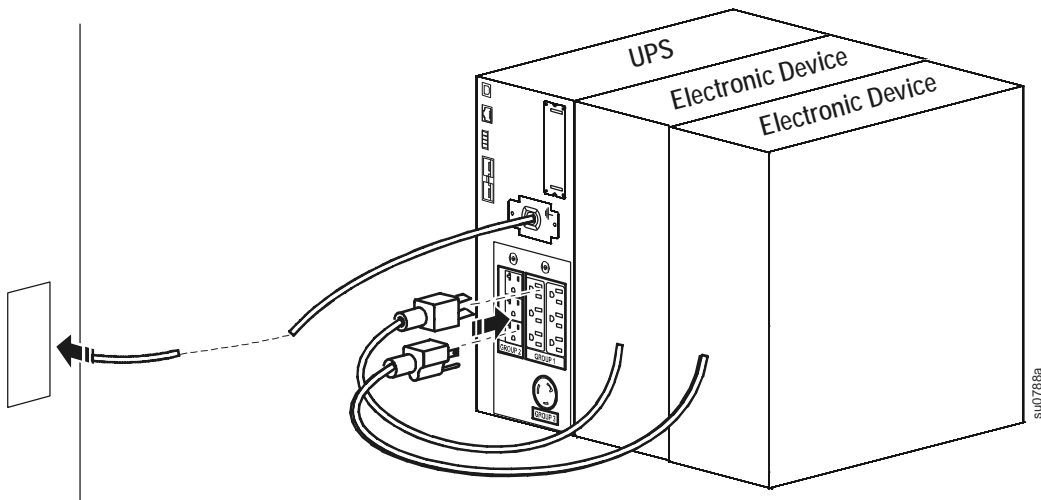



Select models are ENERGY STAR[®] qualified.

For more information go to www.apc.com/site/recycle/index.cfm/energy-efficiency/energy-star/